

**Mult
Tasker®**



MT112-108

MT112-107

MANUAL PART NUMBER: 400-0408-002

MT112-107/108

1-IN, 3-OUT / 1-IN, 6-OUT POWER DISTRIBUTION WITH CURRENT SENSE CARD USER'S GUIDE

TABLE OF CONTENTS

	Page
PRECAUTIONS / SAFETY WARNINGS.....	2
GENERAL.....	2
INSTALLATION.....	2
CLEANING.....	2
FCC NOTICE	2
ABOUT YOUR MT112-107/108.....	3
TECHNICAL SPECIFICATIONS.....	3
PRODUCT DESCRIPTION	4
APPLICATION DIAGRAMS.....	5
DIAGRAM 1: TYPICAL SETUP MT112-107.....	5
DIAGRAM 2: TYPICAL SETUP MT112-108.....	6
DIAGRAM 3: INTERNAL VIEW MT112-107.....	7
DIAGRAM 4: INTERNAL VIEW MT112-108.....	8
INSTALLING YOUR MT112-107/108	9
OPERATION.....	9
RS-232 CONTROL.....	9
DESCRIPTION OF COMMANDS	10
COMMAND ORGANIZATION	10
BASIC COMMANDS	10
FEEDBACK CONTROL	12
CARD CONTROL	13
CARD IDs	15
GROUPS	17
SUMMARY OF COMMANDS	18
MENU MODE	19
INDICATORS AND WARNINGS.....	22
TROUBLESHOOTING GUIDE.....	23
LEDs DO NOT TURN ON.....	23
NO OUTPUT POWER.....	23
ALTINEX POLICIES	23
LIMITED WARRANTY/RETURN POLICIES	23
CONTACT INFORMATION	23

PRECAUTIONS / SAFETY WARNINGS 1

Please read this manual carefully before using your **MT112-107/108**. Keep this manual handy for future reference. These safety instructions are to ensure the long life of your **MT112-107/108** and to prevent fire and shock hazards. Please read them carefully and heed all warnings.

1.1 GENERAL

- Qualified ALTINEX service personnel or their authorized representatives must perform all service.

1.2 INSTALLATION

- To prevent fire or shock, do not expose this unit to water or moisture. Do not place the **MT112-107/108** in direct sunlight, near heaters or heat-radiating appliances, or near any liquid. Exposure to direct sunlight, smoke, or steam can harm internal components.
- Handle the **MT112-107/108** carefully. Dropping or jarring can damage the card.
- Do not pull any cables that are attached to the **MT112-107/108**.
- Insert the card carefully into the slots of the MultiTasker without bending any edges.

1.3 CLEANING

- Clean only the connector area with a dry cloth. Never use strong detergents or solvents such as alcohol or thinner. Do not use a wet cloth or water to clean the card. Do not clean or touch any component or PCB.

1.4 FCC NOTICE

- This device complies with Part 15 of the FCC Rules. Operation is subject to the following two conditions: (1) This device may not cause harmful interference, and (2) this device must accept any interference received, including interference that may cause undesired operation.

- This equipment has been tested and found to comply with the limits for a Class A digital device, pursuant to Part 15 of the FCC Rules. These limits are designed to provide reasonable protection against harmful interference when the equipment is operated in a commercial environment. This equipment generates, uses, and can radiate radio frequency energy and, if not installed and used in accordance with the instructions found herein, may cause harmful interference to radio communications. Operation of this equipment in a residential area is likely to cause harmful interference in which case the user will be required to correct the interference at his own expense.
- Any changes or modifications to the unit not expressly approved by ALTINEX, Inc. could void the user's authority to operate the equipment.

ABOUT YOUR MT112-107/108 2

MT112-107 & MT112-108 1-In and 3- or 6-Out Power Distribution with Current Sense International Version

The **MT112-107** is a 1-In, 3-Out AC Power Distribution Card and the **MT112-108** is a 1-In, 6-Out AC Power Distribution Card.

The **MT112-107/108** distributes AC power from a single AC source to multiple AC outlets. These outlets can be connected to any type of audio/video equipment. The total current supplied to all outlets must be less than 10 A. Built-in sensors alert the user by flashing the LEDs when the load exceeds 8.5 A and a warning message is sent to the RS-232 bus when the current draw is near maximum.

When the equipment connected to the **MT112-107/108** draws 9.5A or more for 3 s, the card will automatically start turning outlets off, starting with the highest outlet number first. A message informing the user that outputs are being shutdown will be sent to the RS-232 bus.

The **MT112-107/108** is able to turn audio/video equipment on or off in a sequential order, which may be defined using RS-232 protocol commands. The time delay between switching is also programmable from 0-50 s.

The **MT112-107/108** has built-in current measuring circuits to detect load levels. The value of these loads may be read over the RS-232 bus. The measurement is in amps and can monitor the load level on any or all outputs.

The threshold level for the on/off detect feature is adjustable to accommodate different loads and determine when AV equipment is on or off. This feature is especially important for VCRs and DVD players or any other equipment that has only IR control capabilities. Using this feature, the control system can determine if the device is on or off by the amount of current it draws.

TECHNICAL SPECIFICATIONS 3

Specifications are subject to change.
See www.altinex.com for up-to-date information.

FEATURES/DESCRIPTION	MT112-107/108
Inputs	
MT112-107/108	(1) IEC Power Entry - male
Outputs	
MT112-107	(3) IEC 320 Power Outlet, female
MT112-108	(6) IEC 320 Power Outlet, female

Table 1. **MT112-107/108** General

MECHANICAL	MT112-107/108	
MT112-107: Slots	3	
Weight	1.28 lb (0.58 kg)	
MT112-108: Slots	4	
Weight	1.83 lb (0.83 kg)	
T° Operating	10°C to 50°C	
T° Maximum	0°C to 75°C	
Humidity	90% non-condensing	
MTBF (calc.)	40,000 hrs	

Table 2. **MT112-107/108** Mechanical

ELECTRICAL	MT112-107/108	
Input Signals		
AC	240 VAC/10 A maximum	
Output Signals		
AC	240 VAC/10 A maximum	
Warning Level	8.5 A	
Shutdown Level	9.5 A > 3 s	
Shutdown Seq.	Output 6,5,4,3,2,1	
Enclosure Power	MT112-107	MT112-108
+6V	50 mA (0.3 W)	50 mA (0.3 W)
-6V	50 mA (0.3 W)	50 mA (0.3 W)
+13V	90 mA (1.2 W)	240 mA (3.1 W)
Total Power	1.8 W max.	3.7 W max.

Table 3. **MT112-107/108** Electrical

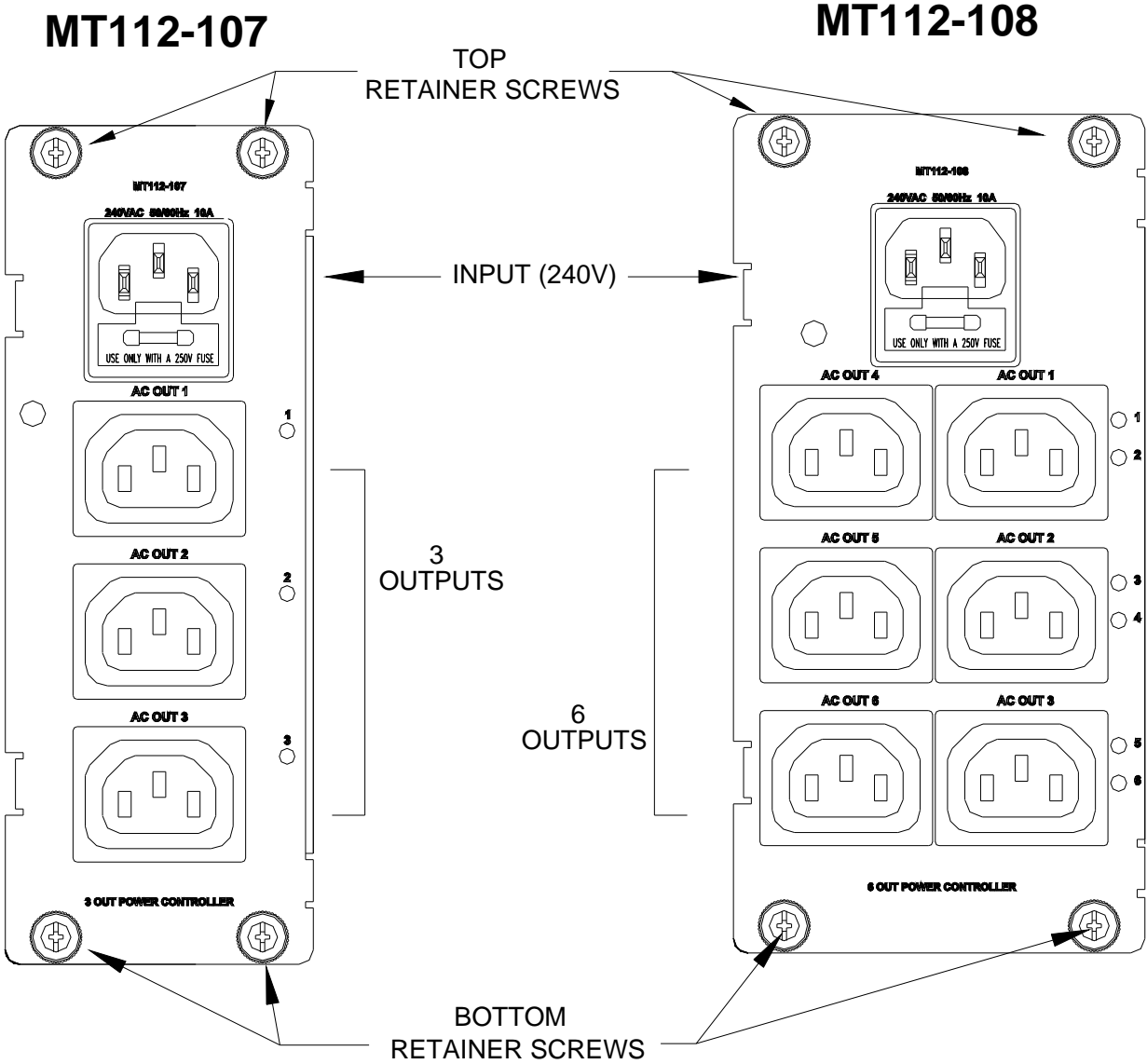

DIAGRAM 1: TYPICAL SETUP MT112-107

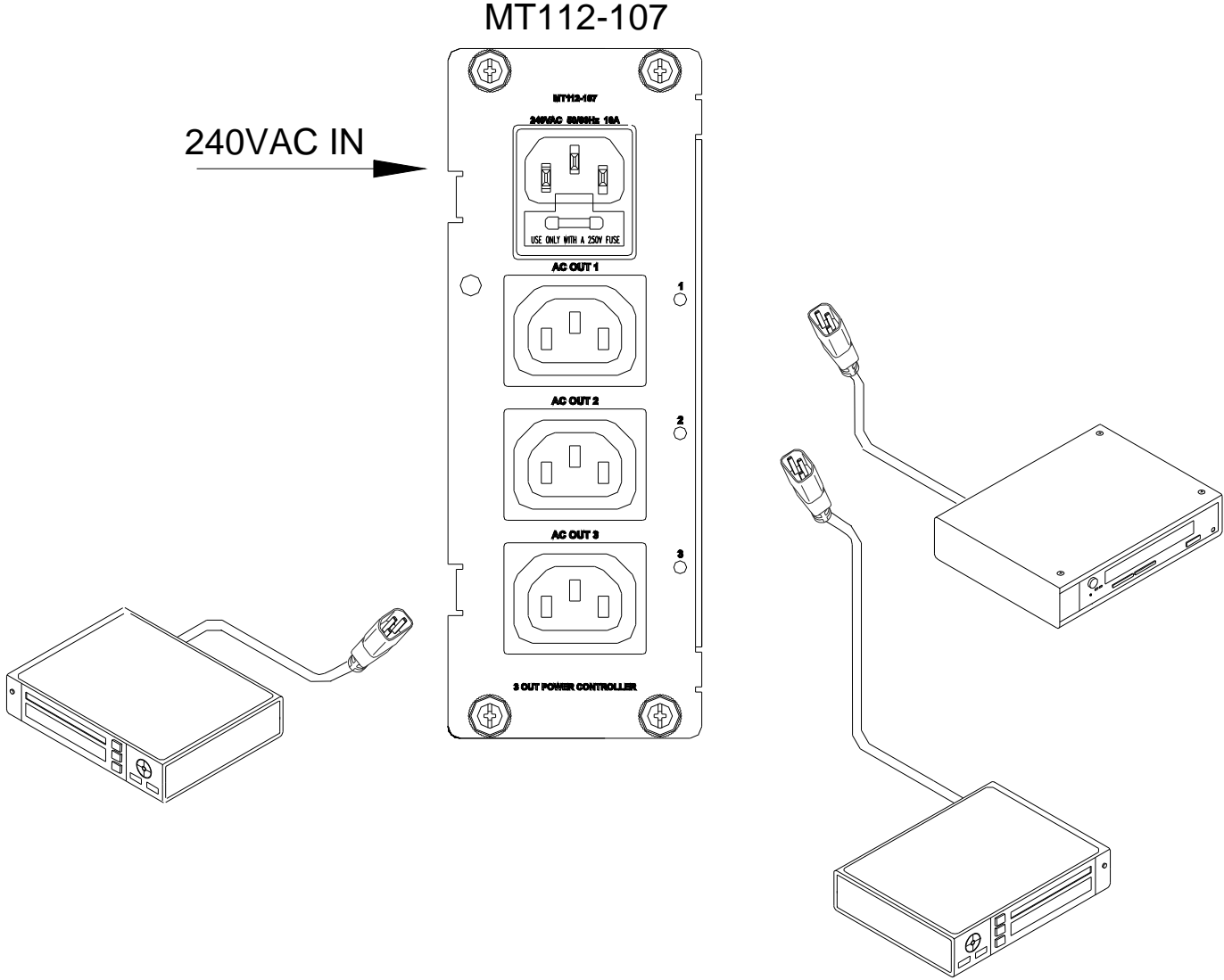

DIAGRAM 2: TYPICAL SETUP MT112-108

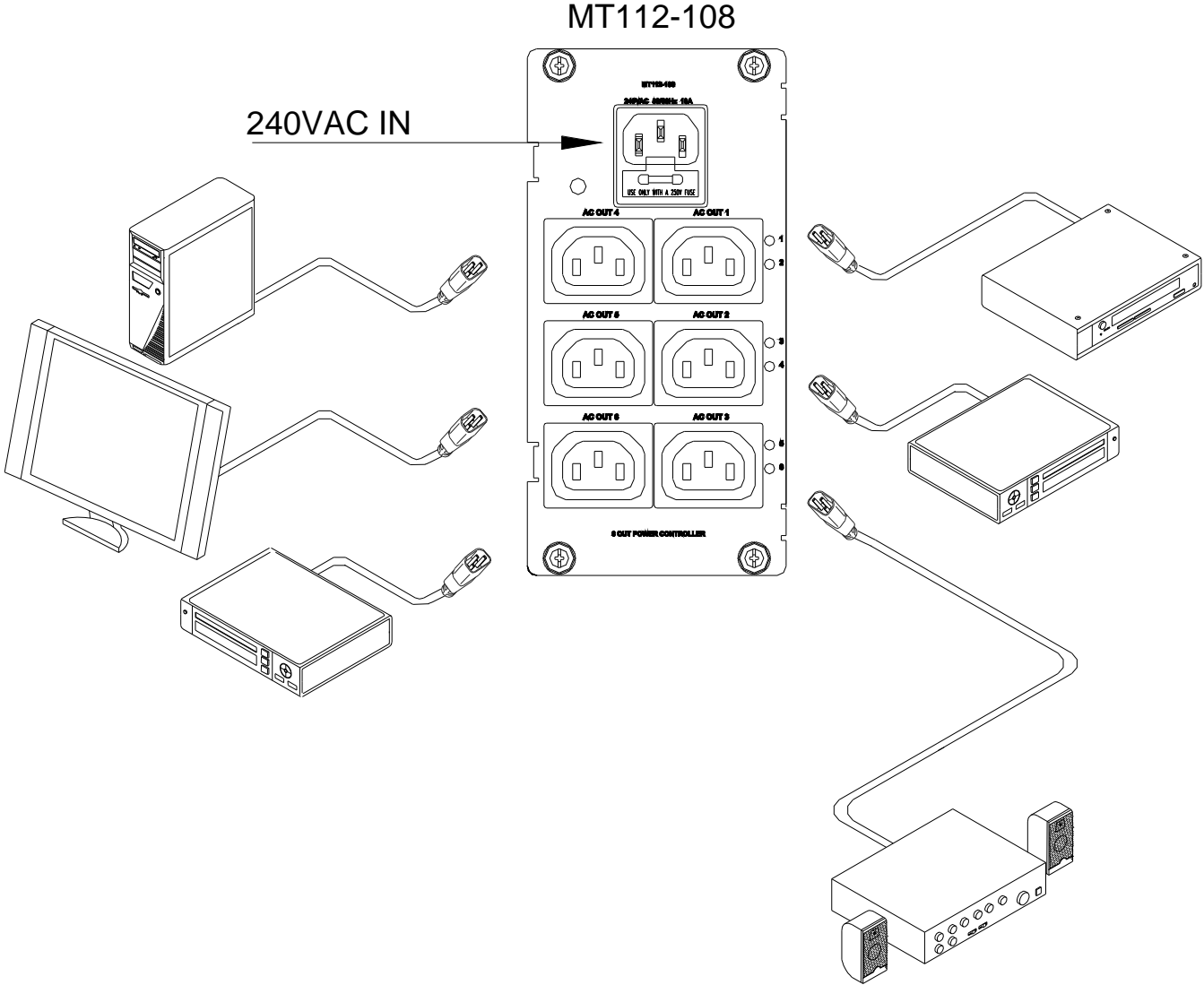
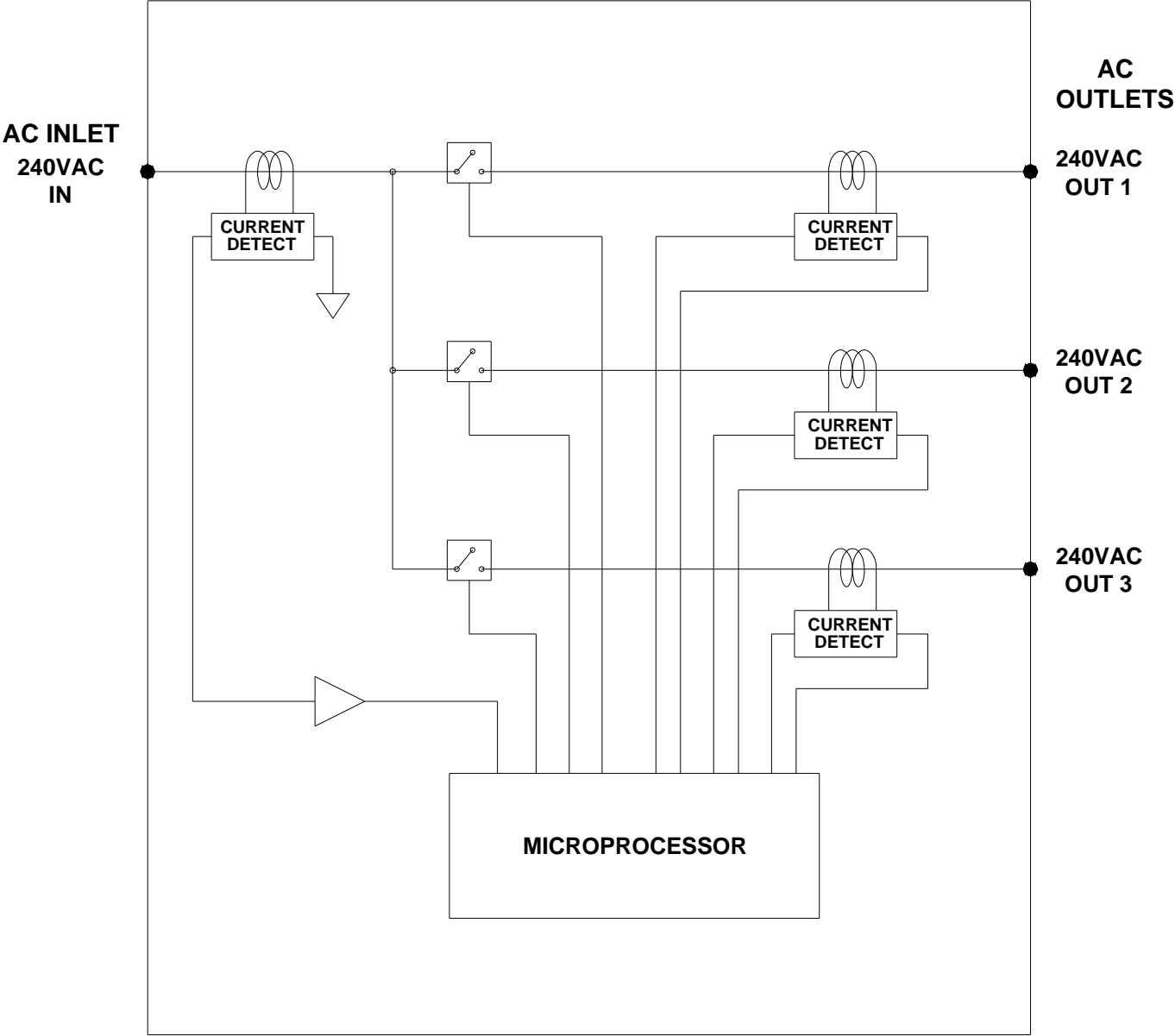
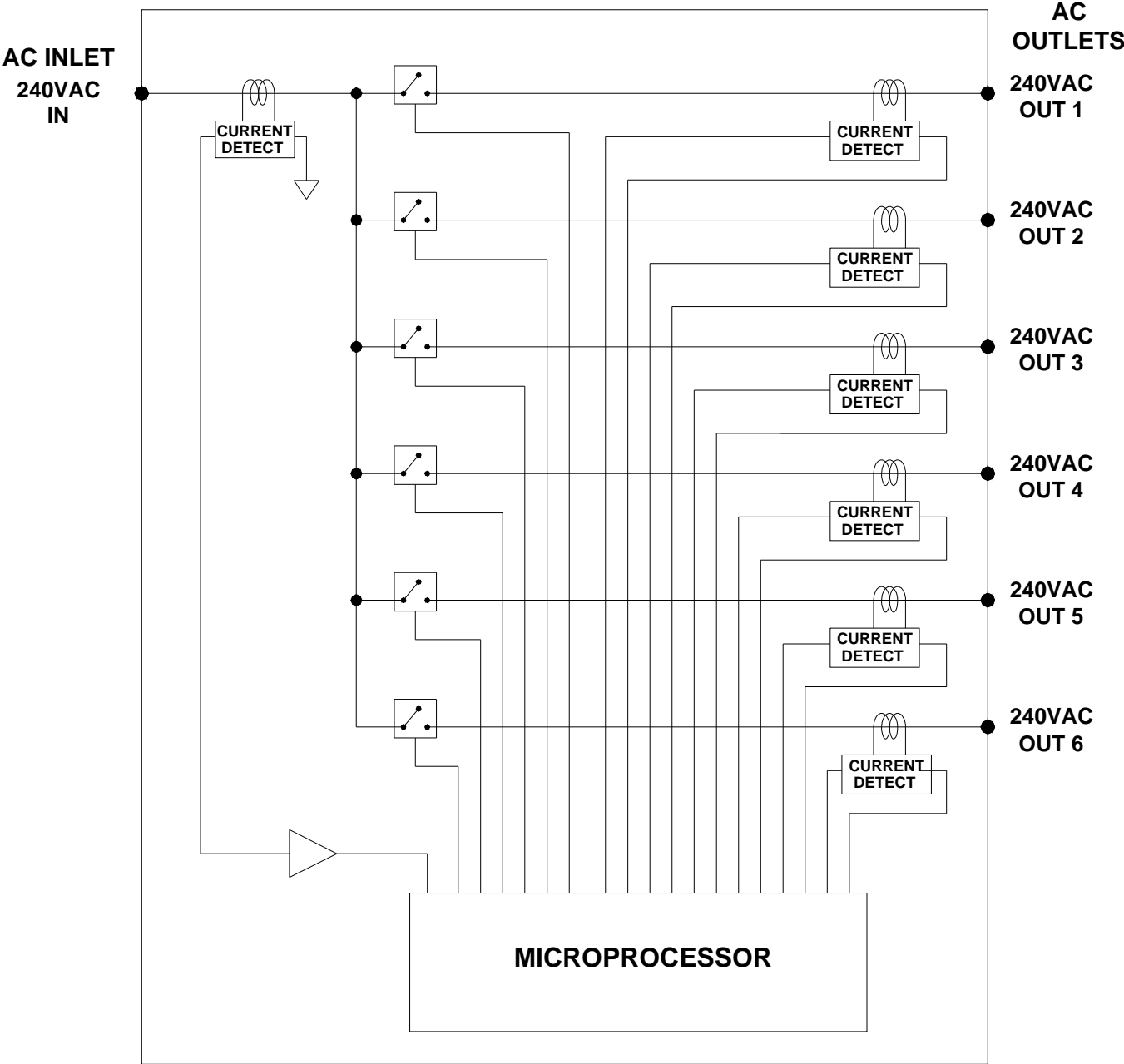

DIAGRAM 3: INTERNAL VIEW MT112-107



MULTITASKER

DIAGRAM 4: INTERNAL VIEW MT112-108



INSTALLING YOUR MT112-107/108 6

- Step 1.** Turn off power to the MultiTasker system and disconnect from AC power.
- Step 2.** Remove an unused slot cover (MT200-101) from the enclosure.
- Step 3.** Slide the **MT112-107/108** into an available slot in the MultiTasker enclosure in order to connect it to the bus. Make sure that the **MT112-107/108** card fits into place and secure the card by tightening the top and bottom retainer screws.
- Step 4.** Identify the slot number of the **MT112-107/108** and note that it is for RS-232 control.
- Step 5.** Restore power to the MultiTasker system.
If the outputs are enabled, the LEDs should be on and red.
- Step 6.** Connect AC power to the card's input power using the standard power cord provided.
- Step 7.** Make sure the outputs are disabled before plugging any equipment into the AC outlets. Also, make sure the equipment is turned off before plugging it into the card.
- Step 8.** The **MT112-107/108** is now operational.

OPERATION 7

7.1 RS-232 CONTROL

The **MT112-107/108** has many advanced remote-control capabilities accessible through standard RS-232 communication. Control may be accomplished through a computer, control system, or any device capable of RS-232 communication.

7.1.1 RS-232 INTERFACE

The control commands for the **MT112-107/108** are in a simple ASCII character format.

1. **Square brackets “[]” are part of the command.**
2. **Use uppercase letters for all commands.**
3. **Spaces are not legal characters.**

The cards in a MultiTasker are capable of performing various functions, as well as providing feedback to the user or control system. Commands instruct a card to perform specific actions or request information from the card. Some commands do both simultaneously.

A command that instructs the card only to perform an action will generate feedback of “[]”. The open bracket immediately followed by a closed bracket indicates the card received a valid command. If the command requested information from the card, the feedback generated by the card is the acknowledgement of having received a valid command. Invalid commands generate feedback that includes “ERR” plus an error code.

Example: [ERR001]

After processing a command, an “OK” or error will be returned as feedback if “F” is included at the end of a command string.

Commands ending in “S” will be saved into memory. Commands not ending in “S” will still be executed, but will not be restored when the system is reset or powered off, then on.

7.2 DESCRIPTION OF COMMANDS

Each command consists of three parts: Function, Card ID, and Unit ID.

[Function , Card ID , Unit ID]

Example: [VERC3U2]

VER = Function

C3 = Card ID or Group ID

U2 = Unit ID (optional for Unit ID 0)

For Function, see a detailed explanation under each command description.

The card ID is a unique identifier. It is equal to the enclosure slot number, or it may be an assigned value. As the slot number, the value can range from 1-4 up to 1-20 depending on the enclosure. If the value is assigned, the ID may be a maximum of 99. Card ID 0 (C0) is used for the controller and cannot be reassigned.

The group ID is a number representing a group of cards defined with the [WR] command. When using the group ID, all cards in the group will perform the given instruction.

NOTE: In this guide, cards are referenced by their IDs (C1, C2...C99). Typically, the ID number will be equivalent to the slot number. Groups will be referenced by their IDs (G1-G8).

Changing the position of a card will significantly affect the commands recorded on software definitions or third-party control systems.

The unit ID has a range from U0 to U20. U0 should be used for single unit operation. If the ID is set to U0, each command may be used without Ui. Use the command [SETU0], as explained in the MT101-101 User's Guide.

Example:

[VERC3]: For U0

[VERC3Ui]: For ID other than U0

[VERC3]: Equivalent to [VERC3U0]

COMMAND ORGANIZATION

The COMMAND SUMMARY (Section 7.3) gives one-line descriptions of each command. Commands in this section are organized into 5 groups:

Basic Commands

Feedback Control

Card Control

Card IDs

Groups

BASIC COMMANDS

The basic commands are used to provide general information about the card. These commands are most useful during the initial stages of setting up and operating the card.

1. [VER]

This command displays the software version and card type for the **MT112-107/108** card.

Command Format: [VERCnUi]

Cn = Card ID (n = slot from 1 to max slots)

Ui = Unit ID (i = # from 0 to 9)

Example:

An **MT112-107** card is in slot 4. Send the command [VERC4], and the MultiTasker Enclosure will return feedback as:

[MT112-107 690-0189-008 C04]

MT112-107 = model number

690-0189-008 = software version

C04 = card ID/slot number

2. [C]

This command displays the status of the card.

Command Format: [Cn]

Cn = Card ID (n = # from 1 to max slots)

Example Feedback for MT112-108:

ON SEQUENCE: 123456, T=01 (0.5 Sec)

OFF SEQUENCE: 654321, T=01 (0.5 Sec)

OUTPUT LOAD(A) THR(A) SIGNAL

1:On 1.500 0.500 On

2:On 0.250 0.500 Off

3:Off 0.000 0.500 Off

4:Off 0.000 0.500 Off

5:Off 0.000 0.500 Off

6:Off 0.000 0.500 Off

In the above example, Relay 1 is on (1:On), the actual load current is 1.5 A, the threshold current is 0.5 A, and since the actual current exceeds the threshold current, the Signal is "On". The signal is considered on if the measured current (1.5A) is greater than its threshold (0.5A). In this case, the Signal is on. See the [THR] command for details on threshold setting.

In the above example, relay 2 is on (2:On), but the load is off. The load is considered off because the threshold level is 500 mA and the output load is only at 250 mA.

3. [CnS]

This command saves the card's settings. This configuration will be restored after the system is reset or powered off, then on again.

Command Format: [CnS]

Cn = Card ID (n = # from 1 to max slots)

S = Save configuration

Example:

Send the command [C4S] to save the settings for the card in slot 4. The feedback will be in the following format:

ON SEQUENCE: 123456, T=01 (0.5 Sec)

OFF SEQUENCE: 654321, T=01 (0.5 Sec)

OUTPUT LOAD(A) THR(A) SIGNAL

1:On 1.500 0.500 On

2:On 0.250 0.500 Off

3:Off 0.000 0.500 Off

4:Off 0.000 0.500 Off

5:Off 0.000 0.500 Off

6:Off 0.000 0.500 Off

[SAVED C04]

Outputs 1 and 2 are enabled and all thresholds are set to 500 mA. The information for Signal On/Off and the measured current values are displayed, but are not saved because they are measured values. Additionally, the card also saves the threshold values and sequence information.

4. [TEST]

This command performs a test on the internal memory. Upon completion, the system will display the following:

MEMORY IC IS GOOD

Otherwise, failures will be indicated.

5. [HELP]

This command displays information available for the MultiTasker interface commands.

Command Format: [HELPCn]

Cn = Card ID (n = # from 1 to max slots)

Example:

In order to display the RS-232 commands available for the **MT112-107/108** card in slot 4, send the command [HELPC4]. The commands along with a brief description will be displayed.

FEEDBACK CONTROL

The next commands are functions of both the card and the front panel. They allow flexibility over when and how card information is displayed.

6. [FBD]

This command turns feedback delay on or off. It is necessary when installing some newer cards in older systems. If the system does not receive all of the feedback from the card, the card may be communicating too fast. This command will slow down the card's communication rate.

Command Format: [FBDm]

m = Delay (0= no delay, 1= delay 100mS)

Example:

The command [HELPC4] is sent to the card in slot 4. Some of the HELP file is displayed on the screen, but most is missing. Send the command [FBD1] to slow down the rate at which the card sends feedback to the system.

7. [?]

This command displays general information about the MultiTasker and the cards installed.

Command Format: [?Ui]

Ui = Unit ID (i = from 0 to 9)

Example:

A MultiTasker with Unit ID 1 has a front panel with part number MT101-101 and contains an MT112-108. Send the command [?U1] and receive the following feedback:

[(MT101-101U1)(MT112-108C04)]

MT101-101U1 = Front Panel MT101-101, ID 1

MT112-108C04 = MT112-108 with card ID 4

8. [?C]

This command displays general information about the card and its status.

Command Format: [?Cn]

Cn = Card ID (n = # from 1 to max slots)

The **MT112-107** in slot 4 has Input 1 on. The on sequence is 1,2,3 and the off sequence 3,2,1. Send the command [?C4] to receive the feedback status. For example:

[(MT112-107C04)(VR690-0189-008C04)
(ON100C04)(SN123T2C04)(SF321T2C04)
(SI100C04)(TH010000000000C04)
(LD026400000000C04)]

All status feedback is enclosed in brackets, “[]”. Each data field in the status is enclosed in parentheses. The first 2 characters identify the status type and the last 3 are the card ID.

MT112-107	= Model number
VR690-0189-008	= Firmware version
ON100	= Output ON/OFF status
SN123T2	= ON sequence
SF321T2	= OFF sequence
SI100	= Signal Detect
TH010000000000	= Threshold levels
LD026400000000	= Measured loads

The on/off status line is read from left to right as outputs 1-3. A "1" indicates the output is enabled and a "0" indicates the output is disabled or off.

The sequence lines show the order in which the outputs are enabled and disabled. The delay time between switching outputs on or off is 0.5 times the number following the "T". For example, T4 is a 2 s delay.

The signal detect line shows a "1" for any outputs where the load exceeds the threshold current. In this case, the load on Output 1 exceeds the threshold current.

Each threshold and measured load value is represented as a 4-digit number in milliamps. The first 4 digits are for Output 1, the next Output 2, and so on. The above example shows the threshold for Output 1 set to 100 mA and the current measured on Output 1 is 264 mA.

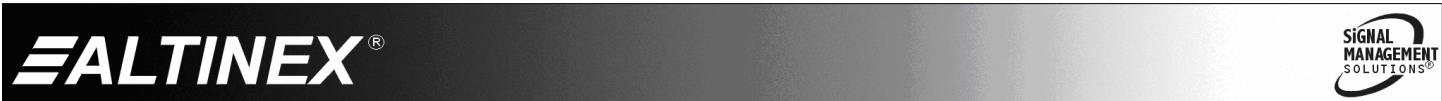

9. [STA1]

This command enables automatic feedback from the front panel and affects any card with auto-feedback capability, not just the **MT112-107/108**. The default at power on or reset is STA0, off. For more details, see the [?Cn] command definition.

Command Format [STA1] = On

Feedback Prefix Definitions:

ON = Output enable

SI = Signal/load present

Example:

Command = [OFF1C4]

Feedback = (ON011C04)

ON = output enable

011 = 1 off, 2 and 3 on

C04 = card ID

10. [STA0]

This command disables automatic feedback from the card and front panel. The command affects any card with auto-feedback capability, not just the **MT112-107/108**. The default at power on or reset is STA0, off.

Command Format [STA0]

CARD CONTROL

Card control commands allow the main functions of the card to be executed over the RS-232 bus, or programmed for use from the front panel keys.

11. [ONn]

This command enables a single output. The LED for each enabled output is red, unless the current draw is greater than the threshold value. In that case, the LED is green.

Command Format: [ONmCn]

m = Output number (m = 1 to 3, or 1 to 6)

Cn = Card ID (n = # from 1 to max slots)

Example:

Send [ON2C4] to enable Output 2 of C4. The LED for Output 2 should be on and red.

12. [ON]

This command enables all outputs.

The LED for each enabled output is red, unless the current draw is greater than the threshold value. In that case, the LED is green.

Command Format: [ONCn]

Cn = Card ID (n = # from 1 to max slots)

Example:

Send [ONC4] to enable all outputs of C4. The outputs will be turned on with the delay and sequence defined by the [SON] command.

13. [OFFn]

This command disables a single output.

The LED for each disabled output will be off.

Command Format: [OFFmCn]

m = Output number (m = 1 to 3, or 1 to 6)

Cn = Card ID (n = 1 to max slots)

Example:

Send the command [OFF2C6] to disable Output 2 of C6.

14. [OFF]

This command disables all outputs.

The LED for each disabled output will be off.

Command Format: [OFFCn]

Cn = Card ID (n = # from 1 to max slots)

Example:

Send the command [OFFC6] to disable all outputs of C6. The outputs will be turned off with the delay and sequence defined by the [SOFF] command.

15. [SON]

This command displays the turn on sequence.

Command Format: [SONCn]

Cn = Card ID number (n = 1 to max slots)

Example MT112-108:

The turn on sequence is set to the order 1,2,3,4,5,6 with a delay of 1 s between each switch. Send [SONC4] to display the following feedback:

SON123456T2

16. [SON...]

This command sets the sequence and delay time between enabling outputs. It is used by the [ON] command when turning on all outputs.

Command Format: [SON^^^^TyyCn]

^^^^ = Sequence (^ = outputs, 3 or 6)

yy = Delay time multiple of 0.5 s
(yy = 00-99)

Cn = Card ID number (n = 1 to max slots)

Example:

Send [SON654321T2C4] to set the ON sequence to enable outputs in the order of 6, 5, 4, 3, 2, 1, with a delay time of 1 s between enabling each output.

17. [SOFF]

This command displays the turn off sequence.

Command Format: [SOFFCn]

Cn = Card ID number (n = 1 to max slots)

Example:

The turn off sequence is set to the order of 6, 5, 4, 3, 2, 1, with a delay of 1 s between each switch. Send [SOFFC4] to display the following feedback:

SOFF654321T2

18. [SOFF...]

This command sets the sequence and delay time between disabling outputs. It is used by the [OFF] command when turning off all outputs.

Command Format: [SOFF^^^^TyyCn]

^^^^ = Sequence (^ = output numbers 1-6)

yy = Delay time multiple of 0.5 s
(yy = 00-99)

Cn = Card ID number (n = 1 to max slots)

Example:

Send [SOFF654321T2C4] to set the turn OFF sequence to disable outputs in the order of 6, 5, 4, 3, 2, 1, with a delay time of 1 s between disabling each output.

19. [THR]

This command displays the threshold settings. The threshold level is used to indicate if a load is present on an output. If the load is greater than the threshold, the feedback from the status command [C] shows the signal is on.

Command Format: [THRCn]

Cn = Card ID (n = # from 1 to max slots)

Example MT112-107:

Send the command [THRC4] and the system will return feedback similar to the following:

[THR1=0500mAC04][THR2=0500mAC04]
[THR3=0500mAC04]

In this example, all the thresholds are set to 500 mA for C4.

20. [THRn=]

This command sets the current threshold of one or all outputs. The threshold level is used to indicate if a load is present on the output. If the load is greater than the threshold, the feedback from the status command [C] will indicate the signal is on.

Command Format: [THR x = y C n]

x = Output ($x = 1$ to 3, 1 to 6, * for all)

y = Threshold current in mA ($y = 0$ to 9999)

C n = Card ID ($n = \#$ from 1 to max slots)

Example:

There is an **MT112-108** in slot 4. Send the command [THR1=1000C4] to set the current threshold of Output 1 to 1.0 amp.

21. [CLR]

This command performs a reset on the card and forces all settings to factory defaults.

Command Format: [CLRC n]

C n = Card ID number ($n = 1$ to max slots)

Example:

Send the command [CLRC4] to reset the board in slot 4 to its factory defaults. After clearing the card, all outputs will be enabled and all thresholds will be set to zero.

22. [SIG m]

This command displays the load measured on a single output. The value is on amps.

Command Format: [SIG m C n]

m = Output Number ($m = 1$ to 3, or 1 to 6)

C n = Card ID ($n = \#$ from 1 to max slots)

Example:

There is an **MT112-108** in slot 4. Output 1 is drawing 550 mA of current. Send the command [SIG1C4] to read the current. The system will return the following feedback:

[0.550AC04]

If the threshold for Output 1 is less than 550 mA, then the board status will show that a load is present on the output. Sending the command [C4] will yield feedback similar to the following:

ON SEQUENCE: 123456, T=04 (2 Sec)

OFF SEQUENCE: 123456, T=02 (1 Sec)

OUTPUT LOAD(A) THR(A) SIGNAL

1:On 0.550 0.500 On

2:On 0.000 0.000 Off

3:On 0.000 0.000 Off

4:On 0.000 0.000 Off

5:On 0.000 0.000 Off

6:On 0.000 0.000 Off

23. [SIG]

This command displays the load measured on all outputs and displays the level in amps.

Command Format: [SIGC n]

C n = Card ID ($n = \#$ from 1 to max slots)

Example:

There is an **MT112-108** in slot 4. Output 1 is drawing 0.5 A, Output 2 is 1 A, and Output 6 2 A. Send the command [SIGC4] to read the total current to all outputs. The system will return the following feedback:

[3.500AC04]

CARD IDs

The default card ID is the same as the card slot number. The next several commands allow the user to change the card ID to a value other than the slot number. Once the ID is changed, moving the card to another slot will not change the card ID. If a card in slot 4 is set to ID 1, then moved to slot 10, its ID will remain 1. The [RSI] command forces each installed card to take its slot number as its ID number, regardless of the slot in which it is installed.

Some cards require more than one slot in the MultiTasker system. As an example, some matrix switcher cards require 4 slots. If 5 of these cards are installed, they would be numbered C4, C8, C12, C16, and C20. Changing the ID allows the user to define the cards as C1, C2, C3, C4, and C5.

Another use for changing the card ID is to be able to use multiple systems without having to set each unit to a different unit ID. All systems may be left as unit ID 0 for ease of programming. The cards in the first unit may be numbered 1-10 and in the second unit 11-20.

The ID commands work with all MultiTasker systems. However, front panels that have firmware releases prior to the following will not be able to address card IDs greater than the number of slots in the system:

690-0122-019 = Version 019 or later.

690-0123-005 = Version 005 or later.

690-0124-019 = Version 019 or later.

Send the command [VER] to the system and the feedback will include the following:

690-0122-019 690-0123-005 690-0124-019

Check the last three digits against the numbers above to determine if the card ID commands can address all 99 card IDs.

24. [RSI]

This command resets the card IDs in the system. After sending this command, each card ID in the system will match the slot number of the card. If the card is moved to another slot, its ID number will be the new slot number.

Command Format: [RSI]

Example:

Send the command [RSI] to the system with Unit ID 0. The card in slot 1 will have ID 1, the card in slot 2 will have ID 2, and so on. If the card in slot 1 is then moved to slot 4, the card ID will then be 4.

25. [SIDn]

This command sets all the cards installed in the MultiTasker system to the same card ID. After sending this command, all cards will be addressed with the same ID. Use caution when sending this command to a system with multiple board types.

Command Format: [SIDn]

n = Card ID (n = # from 1 to 99)

Example:

Send the command [SID1] to the system. All the cards in the system now have ID 1. Any commands that are sent to card ID 1 will be received and executed by each card.

26. [SIDnCi]

This command sets the card ID of a single card to a number from 1 to 99.

Command Format: [SIDnCi]

n = Card ID (n = # from 1 to 99)

Ci = Slot Number (i = # from 1 to max slots)

Example:

Send the command [SID50C10] to set the ID of the card in slot 10 to an ID of 50.

27. [SID+n]

This command sets the card ID of all the cards in a system to their slot number plus the offset value.

Command Format: [SID+n]

n = Offset amount (n = # from 0 to 99)
The maximum card ID is 99, so subtract the highest slot number from 99 to find the maximum offset. For example, in an 8-slot enclosure, the maximum offset would be 91. The slot number (8) plus the offset (91) equals 99.

Example:

There are two 20-slot enclosures to be connected together during normal operation. The first unit will use the default IDs where the card ID is equal to the slot number. The second unit will have the same unit ID, but each card ID will be offset by 20.

Connect the computer to the second unit only and send the command [SID+20] to set the ID of all the cards in the second enclosure to their slot number plus 20. Reconnect both units to the computer.

The cards in the first unit will be referenced as card IDs 1-20 and the cards in the second unit will be referenced by card IDs 21-40.

28. [RSN]

This command displays the slot number of a card with a specified ID number. If more than one card has the same ID, each slot number will be displayed.

Command Format: [RSNCi]

Ci = Card ID (i = # from 1 to 99)

Example:

The card in slot 4 takes up four slots in the enclosure. Its ID was set to 1 since it is the first card installed in the system, reading from left to right. Send the command [RSNC1] to find the slot number of this card. The system responds with the following feedback:

[4]

GROUPS

Group commands allow several cards with the same functions to be controlled simultaneously with a single command. Up to 8 groups (G1-G8) may be defined. These commands apply to all cards, not only the **MT112-107/108**.

29. [WR]

This command adds cards to a group. In MultiTasker systems with audio and video cards, the groups are typically as follows:

Group 1 = Video Cards

Group 2 = Audio Cards

Group 3 = Video and Audio Cards

Command Format: [WRCn₁Cn₂...Gk]

Cn = Card ID (n = slot # from 1 to max slots)

Gk = Group ID (k = # from 1-8)

Example:

Add C2, C4, and C6 to G5 by sending the command [WRC2C4C6G5]. After executing this command, G5 will consist of C2, C4, and C6.

Now add C8 to G5 by sending [WRC8G5]. C8 is added to G5, and G5 is not overwritten. View the contents of G5 by sending [RDG5] and receiving the following feedback:

[G5=C2C4C6C8]

30. [RMC]

This command removes one or more cards from a group.

Command Format: [RMCn₁Cn₂...Gk]

Cn = Card ID (n = # from 1 to max slots)

Gk = Group ID (k = # from 1-8)

Example:

G5 consists of C2, C4, C6, and C8. Remove C6 and C8 by sending [RMC6C8G5]. View the contents of G5 by sending [RDG5] and receiving the following feedback:

[G5=C2C4]

31. [RMG]

This command deletes one or all groups.

Command Format: [RMGk]

Gk = Group ID (k = # from 1-8, * for all)

Example:

Remove all cards from G52 by sending [RMG5].
The system will return the following feedback:

[G5=0]

Example 2:

Remove all cards from all groups, effectively deleting all groups, by sending [RMG*]. The system will return the following feedback:

G1-G8: EMPTY

32. [RD]

This command reads and then displays the members in a group.

Command Format: [RDGk]

Gk = Group ID (k = # from 1-8)

Example:

C2, C4, and C6 make up G5. Read the member data for G5 by sending the command [RDG5]. The system will return feedback as follows:

[G5=C2C4C6]

The feedback shows G5 and then the cards that make up G5. In this case, G5 includes C2, C4, and C6.

7.3 SUMMARY OF COMMANDS

Basic Commands

- 1) [VER] Display software version
- 2) [Cn] Display status of the card
- 3) [CnS] Save card settings
- 4) [TEST] Test memory ICs
- 5) [HELP] Display RS-232 commands

Feedback Control

- 6) [FBD] Set feedback delay
- 7) [?] Display system information
- 8) [?C] Display card status
- 9) [STA1] Enable auto feedback
- 10) [STA0] Disable auto feedback

Card Control

- 11) [ONn] Turn on a single output
- 12) [ON] Turn on all outputs
- 13) [OFFn] Turn off a single output
- 14) [OFF] Turn off all outputs
- 15) [SON] Display ON sequence
- 16) [SON..] Set ON sequence
- 17) [SOFF] Display OFF sequence
- 18) [SOFF..] Set OFF sequence
- 19) [THR] Display current thresholds
- 20) [THRn=] Set current thresholds
- 21) [CLR] Reset card to default values
- 22) [SIGm] Display single load current
- 23) [SIG] Display total load current

ID Commands

- 24) [RSI] Reset Card IDs to defaults
- 25) [SIDn] Set all Card IDs
- 26) [SIDnCi] Set one Card ID
- 27) [SID+] Set all Card IDs to an offset
- 28) [RSN] Display card slot number

Group Commands

- 29) [WR] Add card(s) to a group
- 30) [RMC] Remove card(s) from group
- 31) [RMG] Delete group
- 32) [RD] Display group members

7.4 MENU MODE

Menu Mode commands allow virtually the same functionality as programming commands. Unlike the programming commands in the previous sections, menu commands prompt the user to select from a list of available options. The system then responds based upon selections made by the user.

7.4.1 MENU COMMAND DEFINITIONS

Refer to section 7.2 for details on card functions and examples. Following is a cross-reference of menu mode sections versus programming commands.

MENU	COMMAND
Control	
ON/OFF	[ON], [OFF]
SAVE	[CIS]
CLEAR	[CLR]
Setup	
P/ON SEQ	[SON], [SON...]
P/OFF SEQ	[SOFF], [SOFF...]
RD LOAD LEVEL	[THR], [SIG]
SET LOAD DETECT	[THR]
Status	
	[VER], [C]
Help	
	[HELP]

7.4.2 USING MENU MODE

Do NOT press any keys except those relating to the current menu. If you press the ENTER key after entering a letter or digit, the original list of systems will be displayed.

1. In order to enter Menu Mode, the system needs to be connected to a computer running RS-232 control software.
2. In the Terminal Window, press the ENTER key on the keyboard.
3. The system checks all MultiTaskers on the RS-232 bus and displays a list of available systems.

Example: 1: U1
 2: U2
 3: U3

4. Enter the ID number of the desired system. In the example above, enter a "1" for the MultiTasker with unit ID 1.
5. The system then interrogates all the cards available in its enclosure and displays a list of available cards.

Example: 01: MT103-122
 02: MT103-123
 04: MT112-107

6. Enter the 2-digit ID and a menu for the card will be displayed. In the example above, enter "04" for the **MT112-107**.
7. The system will prompt for selections specific to the selected card.
8. Read each menu carefully, and continue selecting keys as prompted.

NOTE: Menus for data entry have two prompts: "Key=" and "ESC" (escape). Press the escape key to return to the previous menu without making changes.

7.4.3 MENU TYPES

1. MAIN MENU

The first menu displayed after selecting the card is the Main Menu. This menu provides access to the key functions related to the card. Press the key representing the menu item for access and a sub-menu will appear.

2. SUB-MENUS

Each menu item will display either a sub-menu, or a list of options. Press the key corresponding to the desired choice.

7.4.4 MT112-107/108 MENUS

Following are the menus available to the **MT112-107/108**. The first menu is the Main Menu only. The second listing is an expanded view of the menu items. The menus for both cards are the same except for the number of outputs that will be displayed.

The expanded menu contains values that indicate the current setting or value of a parameter. The value is usually in parentheses, or otherwise indicated at the top of a sub-menu. In some cases, additional comments are provided for clarification and are not part of the menu feedback.

System prompts requiring specific values for volume, card number etc. are not shown. See the examples following the menus for details.

MT112-107/108 MAIN MENU

- 1: CONTROL
- 2: SETUP
- 3: STATUS
- 4: HELP
- ESC: GO BACK

MT112-107/108 EXPANDED MENUS

1: CONTROL

- 1: ON/OFF (Turn Outputs On/Off)
 - TOGGLE ON/OFF: PRESS A KEY
 - 0: All OFF
 - 1: Out1 (ON)
 - 2: Out2 (ON)
 - 3: Out3 (ON)
 - 4: Out4 (ON)
 - 5: Out5 (ON)
 - 6: Out6 (ON)
 - 9: All ON
- ESC: GO BACK; S:STATUS

2: SAVE (Save Card Settings)

- ON SEQUENCE: 123456, T=04 (2 Sec)
- OFF SEQUENCE: 123456, T=02 (1 Sec)
- OUTPUT LOAD(A) THR(A) SIGNAL
- 1:On 0.000 0.000 Off
- 2:On 0.000 0.000 Off
- 3:On 0.000 0.000 Off
- 4:On 0.000 0.000 Off
- 5:On 0.000 0.000 Off
- 6:On 0.000 0.000 Off
- SAVE THIS SETTING?
- 1: YES
- 2: NO

3: CLEAR (Set to Defaults)

- RESET CARD TO FACTORY DEFAULT:
- * All Outputs: Turned On
- * Load Detect (threshold): Set to 0
- * Power On & Off Sequence: Set to 123456
- * Delay Time: Set to 2 (1 sec)
- 1: YES
- 2: NO

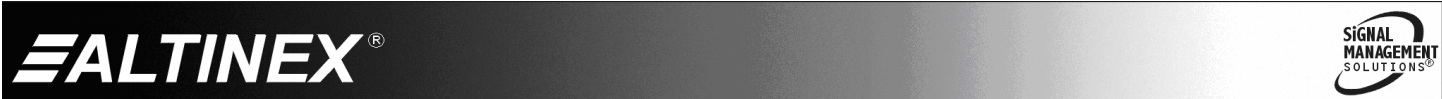

2: SETUP

1: POWER ON SEQUENCE

SET POWER ON SEQ & DELAY TIME

1: ON SEQUENCE: 123456

2: DELAY TIME : 02 (1 Sec)

ESC: ACCEPT & GO BACK

2: POWER OFF SEQUENCE

SET POWER OFF SEQ & DELAY TIME

1: OFF SEQUENCE: 123456

2: DELAY TIME : 02 (1 Sec)

ESC: ACCEPT & GO BACK

3: READ LOAD LEVEL

READ LOAD LEVEL

LOAD 1 = 0.000 A

LOAD 2 = 0.000 A

LOAD 3 = 0.000 A

LOAD 4 = 0.000 A

LOAD 5 = 0.000 A

LOAD 6 = 0.000 A

ESC: GO BACK; S:STATUS

4: SET LOAD DETECT

SET LOAD DETECT (THRESHOLD)

1: THRESHOLD 1 (2000mA)

2: THRESHOLD 2 (0000mA)

3: THRESHOLD 3 (1000mA)

4: THRESHOLD 4 (0000mA)

5: THRESHOLD 5 (0000mA)

6: THRESHOLD 6 (0000mA)

ESC: ACCEPT & GO BACK

After selecting 1 through 6 above, the system will prompt for a value in mA. Press ESC after entering a value and the menu will be redisplayed with the new value.

3: STATUS

This selection displays the card status and then redisplay the Main Menu.

4: HELP

*This selection displays a list of commands available for the **MT112-107/108** along with a brief description.*

ESC

This selection returns you to the parent menu with the listing of all cards.

7.4.5 MENU MODE EXAMPLES

All Menu Mode examples assume an **MT112-107/108** is installed in slot 4 of unit ID 0.

NOTE: The communication software you use may echo each character as it is typed when entering numeric values (not selecting menu items). For example, entering a value of 03 may appear as 0033 on the screen.

1. Enable an Output

Follow the keystrokes below to turn ON Output 3. Assume Output 3 is currently OFF.

Enter List available systems
0 Select unit U0
04 Select MT112-108 in slot 4
1 Select CONTROL Menu
1 Select ON/OFF Menu
3 Toggle Output #3 off/on
S Display new status

The new setting for Output #3 will be displayed in parentheses.

NOTE: Repeatedly pressing key 3 will toggle Output 3 on and off.

ESC Return to the CONTROL Menu
ESC Return to the Main Menu

2. Set the Power ON Sequence

Starting from the Main Menu, set the on sequence to 1-2-3-4-5-6, and the delay time to 3 s. Follow the keystrokes below.

2 Select SETUP Menu
1 Select Power ON Sequence
1 Set ON Sequence
123456 Enter 123456
ESC Accept new setting/redisplay
 The new sequence will be displayed.
2 Select Delay Time
06 Enter 06 (6 x 0.5 = 3 seconds)
ESC Accept the new value/redisplay
 The new delay time will be displayed.
ESC Return to SETUP menu
ESC Return to the MAIN Menu

3. Set Load Detect Level

Starting from the Main Menu, set the load detect for all outputs to 1 A by following the keystrokes below.

2 Select SETUP Menu
4 Select Set Load Detect
1 Select Threshold 1
1000 Enter 1000
ESC Accept new value/redisplay
2 Select Threshold 2
1000 Enter 1000
ESC Accept new value/redisplay
... *Repeat for all outputs.*
ESC Return to SETUP menu
ESC Return to the Main Menu

7.5 INDICATORS and WARNINGS

The **MT112-107/108** can supply a maximum current output of 9.5 A, and has built-in protection in the case of an over-current condition. Each output has its own LED indicator. The LED status indicators and SHUT DOWN control are as follows:

1. If the LED is off, the output is off or disabled.
2. If the LED is red, the output is on but it is drawing less current than the threshold set for that output.
3. If the LED is green, the output is on and drawing more than the threshold current.
4. If the LED is flashing red, the total output current exceeds 8.5 A. This is a warning that maximum load capacity has been reached. The card will provide feedback similar to the following:

ALARM C4

In this example, C4 is refers to the card in slot number 4.

5. The SHUT DOWN procedure begins when the total current draw exceeds 9.5A for more than 3 s. The card will turn off the highest numbered output first. If the load still exceeds 9.5 A after 3 s, the next output will be turned off. This process repeats until the current draw is below 9.5A or all outputs are off. Feedback similar to the following will be sent to the RS-232 bus:

OUTPUT6:OFF C4
OUTPUT5:OFF C4
NO ALARM C4

The ATTENTION message is sent when over-current is sensed. After 3 s, Output 6 is turned off. After another 3 s, Output 5 is turned off. The current draw is now within limits and the "NO ALARM" message is sent.

TROUBLESHOOTING GUIDE 8

We have carefully tested and have found no problems in the supplied **MT112-107/108**; however, we would like to offer suggestions for the following:

8.1 LEDs DO NOT TURN ON

Cause 1: The card cage is not plugged in.

Solution: Plug card cage in. If the LEDs turn on, the problem is solved. If the LEDs are still not lit, see Cause 2.

Cause 2: The card is not in all the way.

Solution: Push the card in all the way. If the LEDs are still not on, see Cause 3.

Cause 3: The outputs are not enabled.

Solution: Use AVSnap® and enable the outputs. If the outputs are on and the LEDs are not on, see Cause 4.

Cause 4: The card cage slot has a problem.

Solution 1: Test the card in other slots of the card cage. If the slot was damaged, the card may work in other slots. If other slots work and the LEDs turn on, the problem is the card cage slot. The card cage may require service, call ALTINEX at (714) 990-2300. If the other slots do not work and the LEDs are still not on, see Solution 2.

Solution 2: Take any other known good card with an LED and verify that the slot used is good by seeing if another card's LED lights in that slot. If it does, then the original card may be the source of the problem. Call ALTINEX at (714) 990-2300.

8.2 NO OUTPUT POWER

Cause 1: The source has a problem.

Solution: Check the source to make sure AC voltage is present and that the power cable is securely installed in the socket. If the source is working, see Cause 2.

Cause 2: The card output is not selected.

Solution: Turn ON the card outputs. See RS-232 accessible commands in section 7. If there is still no power, see Cause 3.

Cause 3: The relays are not closing.

Solution: Use the RS-232 commands, [ON] and [OFF], in section 7 to repeatedly turn each output off and then on. There should be an audible "click" each time a relay is opened or closed. If the relays are working, see Cause 4.

Cause 4: There is excessive current draw.

Solution: Remove all power cables attached to the **MT112-107/108** Output ports. If the LEDs turn on, one of the devices may be bad or drawing too much current.

Plug in one at a time to find the problem device. If all devices are operating normally, call ALTINEX at (714) 990-2300.

ALTINEX POLICIES 9

9.1 LIMITED WARRANTY/RETURN POLICIES

Please see the ALTINEX website at www.altinex.com for details on warranty and return policies.

9.2 CONTACT INFORMATION

ALTINEX, Inc.

592 Apollo Street

Brea, CA 92821 USA

TEL: 714 990-2300

TOLL FREE: 1-800-ALTINEX

WEB: www.altinex.com

E-MAIL: solutions@altinex.com